

Notez que les mobiliers Fornirama sont entièrement assemblés et rembourrés à la main, les spécifications ci-bas sont approximatives et pourraient légèrement différer d'un mobilier à l'autre.  
Note that Fornirama furniture is entirely assembled and upholstered by hand, the specifications below are approximate and may differ from one piece to another.

**A** Hauteur tête baissée = 34"  
Height headrest down

**B** Profondeur totale = 41"  
Total depth

**C** Profondeur de l'assise = 22"  
Seat depth

**D** Hauteur de l'assise = 18"  
Seat height

**E** Largeur du bras = 8"  
Arm width

**F** Hauteur totale tête levée = 42"  
Total height headrest up

Disponibles en version  
inclinaison électrique  
ou stationnaire!  
Available in  
electric reclining  
or stationary version!

Patte de chrome  
Chrome leg



- Pied motorisé inclus sur tous les sièges à bras  
Electric reclining mechanism included on all arm seats

*Electric reclining mechanism included on all arm seats*

- Appui-tête manuel inclus sur toutes les pièces. Système motorisé pour appui-têtes disponibles en option (\$ coût extra)

*Manual headrest is included on all pieces. Motorized headrest system available as an option (\$ at extra cost)*

*Manual headrest is included on all pieces. Motorized headrest system available as an option (\$ at extra cost)*

*Manual headrest is included on all pieces. Motorized headrest system available as an option (\$ at extra cost)*

- Largeur optionnelle du bras: 5" (sans frais)

*Optional arm width: 5" (at no charge)*

- Profondeurs optionnelles du siège: 20" ou 24" (sans frais)

*Optional seat depths: 20" or 24" (at no charge)*

- Pattes de bois optionnel (sans frais)

*Wood legs optional (at no charge)*

- Largeurs de sièges offerts: 24" ou 31"

*Option of two seat widths: 24" or 31"*

**C1-L/R**

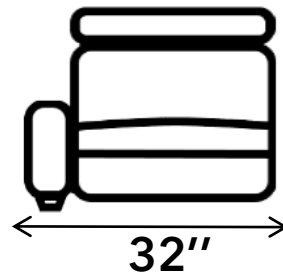

**C0**



**CC0**

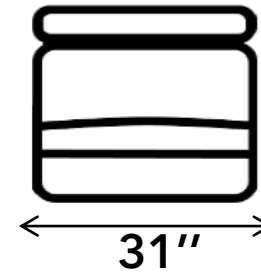

**CC1-L/R**

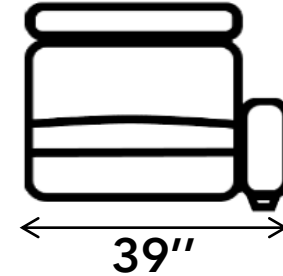

**C**

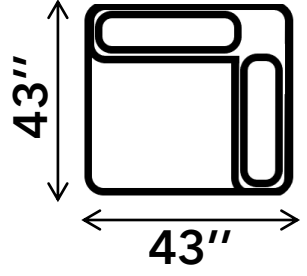

**CLC-L/R**

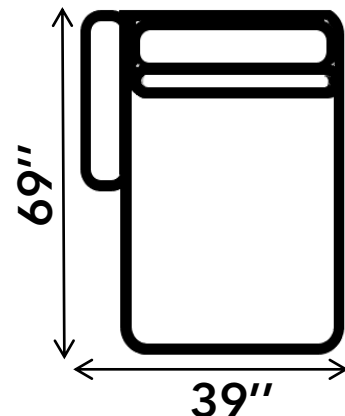

**LC-L/R**

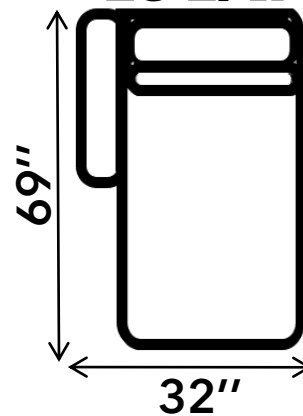

**BW-L/R**

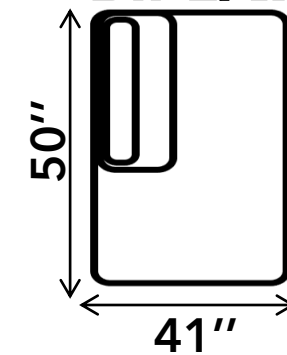

**CBW-L/R**

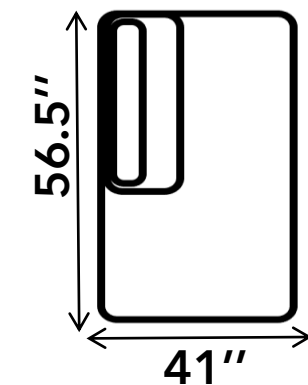

**RC-482**

